

# DGTY5

## 螺桿驅動 Ball Screw Drive

免費服務專線：大陸 400-875-0009 台灣 0800-800-893  
Toll-Free Number China Taiwan



最大行程  
Maximum Stroke 600mm

最高速度  
Maximum Speed 1000mm/s

滾珠螺桿  
Ball Screw  $\phi 12\text{mm}$

馬達容量  
Motor Output 40W

### 型號表示方式 Ordering Method

**DGTY5 - L5 - 100 - M - XC100 - 03 - N1 - A001**

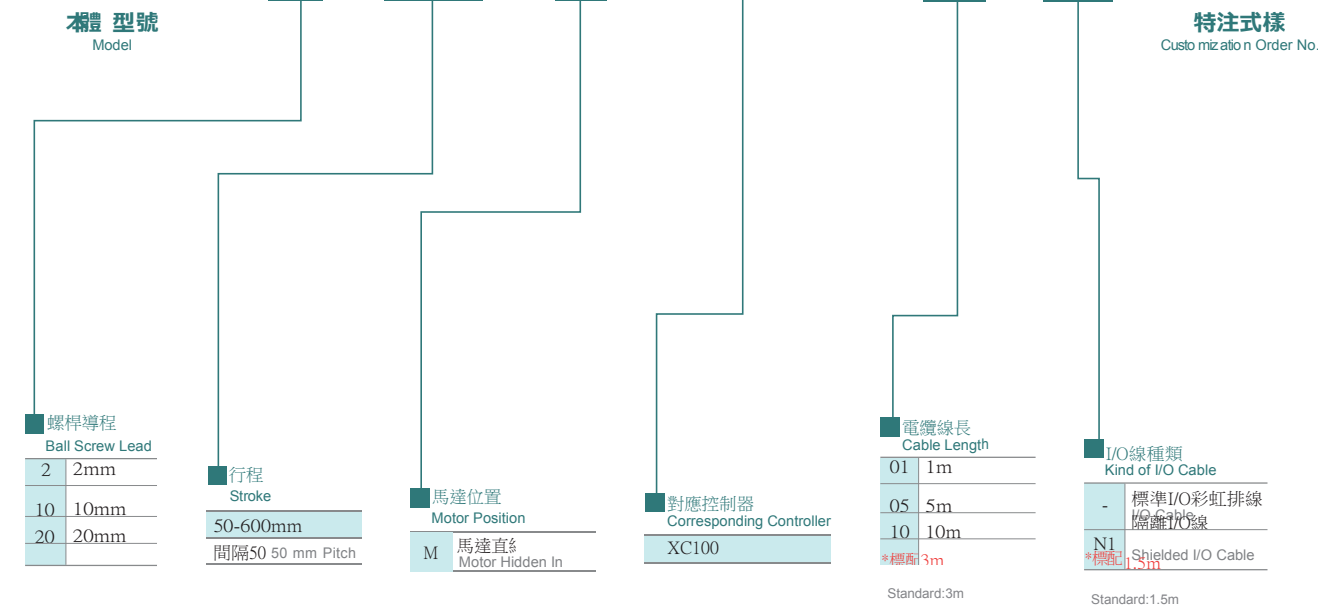

### 基本仕様 Specification

位置重複精度 Repeatability (mm)	$\pm 0.01$				
螺桿導程 Ball Screw Lead (mm)	2	5	10	20	
最高速度 Maximum Speed (mm/s)*1	水平使用 Horizontal	$\leq 100$	$\leq 250$	$\leq 500$	$\leq 1000$
	垂直使用 Vertical *2	$\leq 100$	$\leq 250$	$\leq 500$	$\leq 1000$
最大可搬重量 Maximum Payload	水平使用 Horizontal (kg)	$\leq 30$	$\leq 30$	$\leq 15$	$\leq 10$
	垂直使用 Vertical (kg)	$\leq 10$	$\leq 8.1$	$\leq 2.7$	$\leq 1.4$
定格推力 Rated Thrust (N)	1147	459	229	115	
標準行程 Stroke / Pitch (mm)	50-600mm/50 間隔 50 mm Pitch				
馬達容量 Motor Output (W)	40				
滾珠螺桿規格 Ball Screw Spec	C7 $\phi$ 12mm				

### 出力軸變形量 Shaft Output Deformation Value

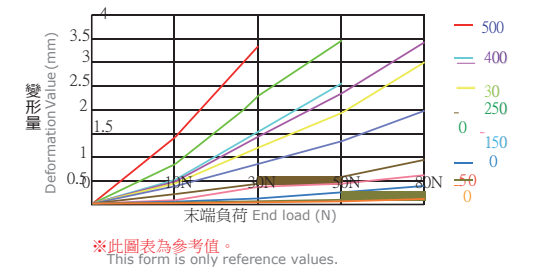

### 水平安裝荷重 Load In Horizontal Installation

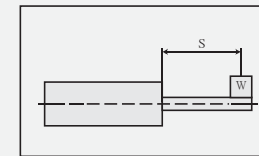
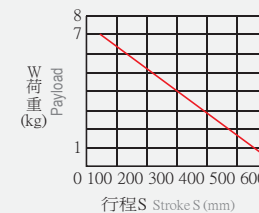

### 垂直安裝負載 Load In Vertical Installation

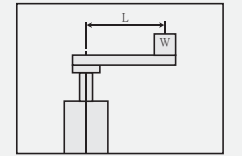
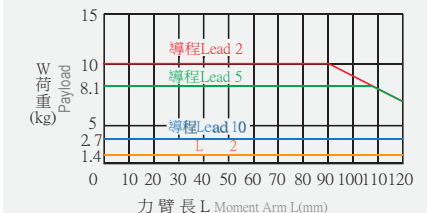

### 出力桿的防止迴轉精度 Anti-rotating Accuracy of Rod

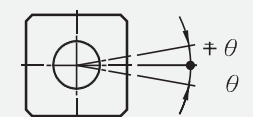

防止迴轉精度  $\theta$   
Anti-rotating accuracy  
 $\pm 0^\circ$

\*內附滾珠滑軌機構, 所以推桿軸心不迴轉。  
With built-in circular guideway, so the rod shaft of actuator does not rotate.

### 對應控制器一覽表 Corresponding Controller Chart

外觀 Exterior	控制器型號 Controller Model	控制介面 Control Mode	特點 Features	電氣規格 Electrical Spec.	詳細參閱 Reference Page
	XC100	Pulse控制	Lin driver 200k Hz Open collector 60k Hz 同時只能使用一種。 Support Line driver and Open collector Max.pulse receiving speed 200k/60k Hz.	控制電路只能使用 24V 額定 電壓 DC24V, 電流 3A 峰值電流 8A。 The voltage of control circuit is 24V only. Operating voltage DC24V, rated current 3A, peak current 8A.	P.167
		I/O控制 I/O Control Mode	利用 I/O 變化, 最多可以執行 127 個 位置控制。 By I/O control, max. 127 positioning points, can be executed.		
		通訊控制	採 Modbus 的 RS485 通訊介面 大並接 16 台) 及一組 mini USB (TOYO-Single 專用)。 Use Modbus as the interface of RS485 (connect max. 16 controllers) and 1 set mini USB. (special for TOYO-Single)		

# DGTY5



## 螺桿驅動 Ball Screw Drive

免費技術專線：大陸 400-875-0009 台灣 0800-800-893  
Tel: Free Number: 400-875-0009 Taiwan: 0800-800-893

M 馬達直結 Motor Hidden In 2D CAD 3D CAD CAD圖面可至www.toyorobot.com下載  
Please download the CAD file from TOYO's website: www.toyorobot.com (單位 Unit : mm)

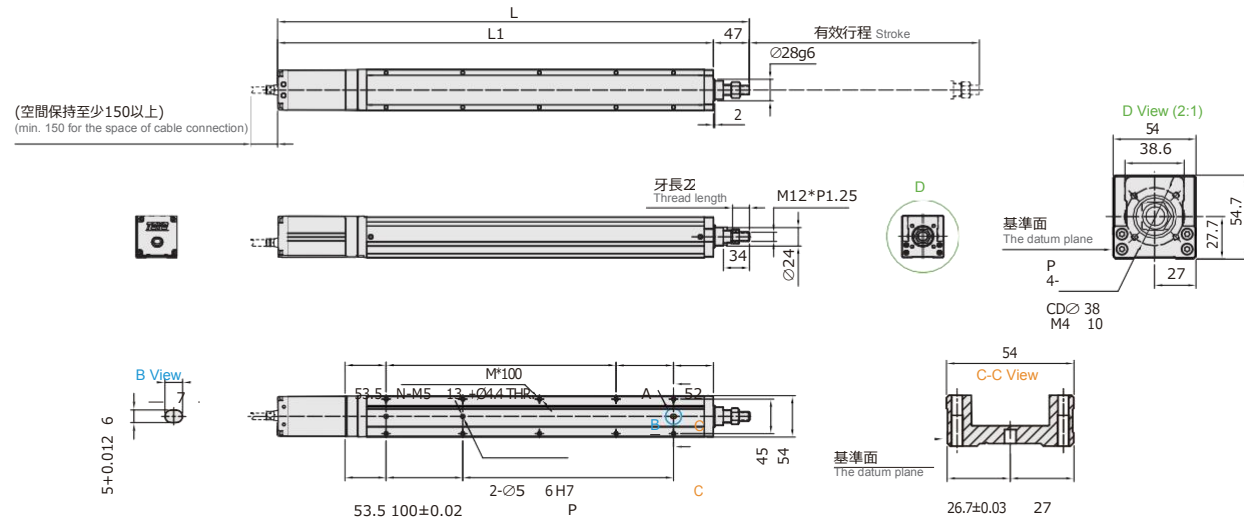

有效行程 Stroke	50	100	150	200	250	300	350	400	450	500	550	600
L	365.5	415.5	465.5	515.5	565.5	615.5	665.5	715.5	765.5	815.5	865.5	915.5
L1	318.5	368.5	418.5	468.5	518.5	568.5	618.5	668.5	718.5	768.5	818.5	868.5
A	25	75	25	75	25	75	25	75	25	75	25	75
M	1	1	2	2	3	3	4	4	5	5	6	6
N	6	6	8	8	10	10	12	12	14	14	16	16
P	25	75	125	175	225	275	325	375	425	475	525	575
*Weight(kg)	1.86	2	2.13	2.32	2.6	2.71	2.73	2.96	3.07	3.16	3.36	3.49

與 Weight of model with motor.

### Memo